

Balsan  
BALSAN

VISION OF  
*elegance*





VISION OF  
*elegance*

**Les grands classiques revisités**

Avec la nouvelle collection d'exception de moquettes Vision of Elegance, Balsan revisite les codes des grands motifs classiques (Art Déco, toile de Jouy, Liberty...) pour leur apporter un souffle contemporain inédit. Destinée aux différents espaces de l'hôtellerie et des bateaux de croisières, cette collection de moquette en velours Balsan trouve le juste équilibre entre l'intemporel et l'air du temps. Sept motifs viennent donner à cette collection une grande richesse créative, qui invite à créer des univers de décoration uniques, insufflant à vos espaces une ambiance chaleureuse et pleine d'élégance.

**A fresh take on iconic staples**

Balsan's exceptional new Vision of Elegance collection draws inspiration from some classic motifs (Art Deco, Toile de Jouy, Liberty, etc.) and gives them an all-new contemporary twist. Designed for different hotel and cruising spaces, this Balsan pile carpet collection strikes the perfect balance between timeless and contemporary. This collection has great creative depth thanks to its seven patterns, inviting you to create unique design universes that imbue your hotel with a warm and elegant atmosphere.

**Neu aufgelegte Klassiker**

Mit den Teppichböden der neuen Ausnahmekollektion Vision of Elegance bedient Balsan sich an den großen klassischen Motiven (Art déco, Toile de Jouy, Liberty u.a.) und verleiht diesen einen völlig neuen und zeitgemäßen Stil. Mit dieser für die verschiedenen Einsatzbereiche im Hotel und Kreuzfahrtschiffen vorgesehenen Veloursteppichboden-Kollektion meistert Balsan den Spagat zwischen Zeitgeist und Zeitlosigkeit. Die sieben Muster der Kollektion sorgen für große kreative Gestaltungsvielfalt und ermöglichen es, einzigartige Stilwelten entstehen zu lassen, die Ihrem Hotel eine behagliche und elegante Atmosphäre verleihen.

*sommaire*

**MADE IN FRANCE** . . . . . p.4  
**STANDARD** . . . . . p.6  
**CUSTOM** . . . . . p.58  
**TECHNICS** . . . . . p.88  
**EXPERTISE TECHNOLOGY** . . . p.88  
*Technologische Expertise*  
**MODE D'EMPLOI** . . . . . p.92  
*How it works*  
*Gebrauchsanweisung*  
**INSTALLATION** . . . . . p.94  
*Verlegung*  
**FICHES TECHNIQUES** . . . . . p.96  
*Technical datas*  
*Technische Datenblätter*

# Made in France

## ESPRIT DE FAMILLE & ETHIQUE

Family Spirit and Ethics  
Familiengeist und  
Verantwortungsbewusstsein



## RESPONSABILITÉ ENVIRONNEMENTALE

Environmental responsibility  
Umweltverantwortung



Station d'épuration sur notre site  
On-site water treatment plant  
Kläranlage an unserem Standort

## PROXIMITÉ AVEC NOS CLIENTS & PARTENAIRES

A close relationship with our customers  
and partners  
Beziehung zu unseren Kunden und Partnern



## QUALITÉ & SAVOIR-FAIRE FRANÇAIS

French know-how and quality  
Qualität und französisches Know-how



## INNOVATION & TECHNOLOGIES D'AVANT-GARDE

Innovation and cutting-edge technologies  
Innovation und revolutionäre Technologien



## CRÉATIVITÉ & PERSONNALISATION

Creativity and customisation  
Kreativität und Personalisierung



VISION OF  
elegance

STANDARD

CUSTOM

TECHNICS

VISION OF  
*elegance*

STANDARD

**4** HUMEURS COLORÉES ..... p 8  
*ambiances steeped in emotion*  
*gefühlvolle Stimmungen*

BOHÈME ..... p 18

DANDY ..... p 22

FLORE ..... p 28

POÉSIE ..... p 34

POMPADOUR ..... p 40

ROMANCE ..... p 44

SMART ..... p 50

# Quatre humeurs chargées d'émotion

Balsan décline pour vous quatre humeurs colorées : des moquettes en velours beiges chaleureux, aux moquettes en velours roses audacieux, qui nous plongent dans des atmosphères émotionnelles très différentes et d'une belle richesse chromatique.

#### FOUR AMBIANCES STEEPED IN EMOTION

*This wealth of colours is reflected in four colourful moods, from warm beige to bold pink pile carpets, immersing us in very different emotional atmospheres complete with rich shades.*

#### VIER GEFÜHLVOLLE STIMMUNGEN

*Balsan spielt für Sie mit vier Farbstimmungen – von Veloursteppichböden in warmen Beigefarben bis hin zu Veloursteppichböden in kühnen Rosatönen, die uns in völlig unterschiedliche Gefühlssphären und eine große Farbpracht eintauchen lassen.*

**27** références  
en standard  
options in stock  
Standardreferenzen

Simplicité naturelle  
Audace nocturne  
Charme poétique  
La vie en rose



# Simplicité naturelle

8 références  
en standard

BOHÈME  
Promesse 940

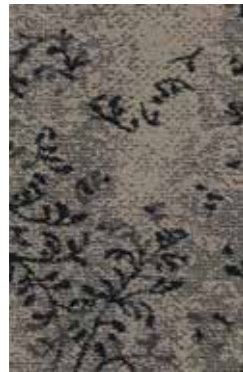

DANDY  
Jasmin 720



DANDY  
Havane 660



FLORE  
Santal 740



POÉSIE  
Nacre 710



POÉSIE  
Sauvage 780



ROMANCE  
Satin 710



SMART  
Bergamote 740



# Audace nocturne

7 références  
en standard

DANDY  
Éternel 180



FLORE  
Velvet 180



POÉSIE  
Caviar 980



ROMANCE  
Minuit 190



SMART  
Blackjack 990

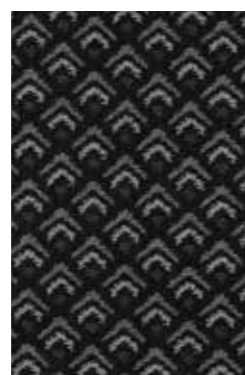

SMART  
Narcisse 950

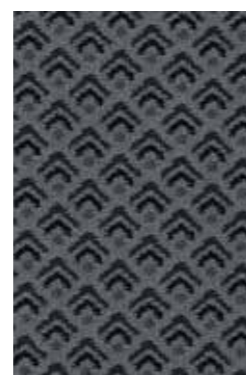

SMART  
Roméo 190

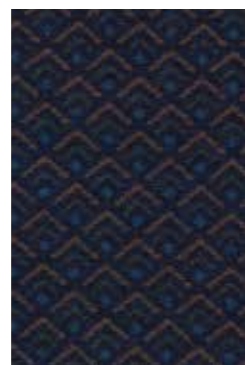

# Charme poétique

6 références  
en standard

BOHÈME  
Jade 710



FLORE  
Orchidée 610



POÉSIE  
Ambre 640



POMPADOUR  
Céladon 230

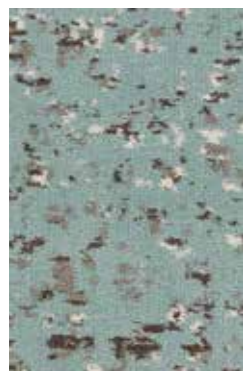

SMART  
Délicat 640



SMART  
Vanille 610





# La vie en rose

6 références en standard

DANDY  
Amour 570



FLORE  
Camélia 580



POMPADOUR  
Candide 620

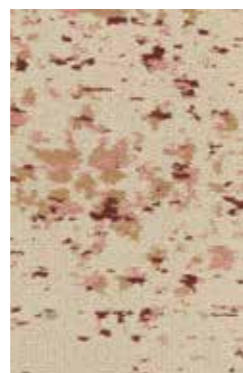

ROMANCE  
Grenade 580



SMART  
Passion 580



SMART  
Poudre 520

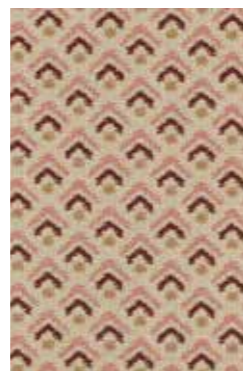

# Bohème

STANDARD

## Un feuillage de printemps en toutes saisons

Évoquant une tendre végétation de printemps, le motif décoratif de Bohème se compose d'un petit feuillage qui s'estompe sur un voile léger. Cet effet de sourdine crée la modernité du motif, qui se laisse deviner plutôt qu'il ne s'impose, avec l'exubérance du Liberty de la Belle Époque.

## Grow spring foliage all year round

Evoking tender spring vegetation, the decorative pattern consists of small foliage fading into a light haze. This muted effect makes the motif seem modern, an impression that is sensed rather than forced upon the onlooker with the exuberance of the Belle Époque's Liberty style.

## Ein Frühlingsblatt zu jeder Jahreszeit

Das dekorative an das sanfte Erwachen der Pflanzen im Frühling erinnernde Muster bildet ein kleines Blättergeflecht, das zu einem leichten Schleier verschwimmt. Dieser Effekt des „Verschwimmens“ macht die Modernität des Musters aus, das sich eher errahnen lässt, als dass es sich mit der Üppigkeit des „Stile liberty“ der Belle Époque aufdrängt.

Promesse 940

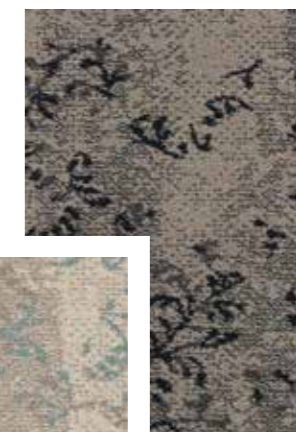

Jade 710



# Bohème

STANDARD

**RACCORD TECHNIQUE**  
Technical repeat  
Technische Verbindungen  
**XY = 133 cm x 119 cm**

**POSE CONSEILLÉE**  
Recommended fitting  
Empfohlene Verlegung  
**LOOK & MATCH** (p 94)

**JOINT LATÉRAL**  
Lateral seam  
Seitennaht  
**40 cm**



4 m



BOHÈME - Promesse 940

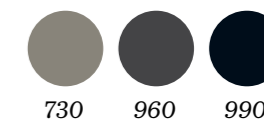

BOHÈME - Jade 710

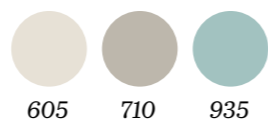

# Dandy

STANDARD

## Le chevron réinventé

« Dandy » reprend le motif en chevron millénaire que les stylistes de Balsan ont réhaussé de pointes colorées pour en dynamiser le style. Élégance, sobriété, et confort sont les maîtres mots de ce grand classique revisité avec tact. Selon l'univers chromatique que vous choisirez, cette moquette en velours à motif chevron donnera un caractère et une luminosité différents à vos espaces.

## A fresh take on herringbone

With "Dandy", Balsan's stylists have put a new spin on the thousand year old herringbone pattern with colourful touches to brighten up the style. Understated elegance and comfort are the keywords of this fresh and tasteful take on a truly classic design. This herringbone pile carpet will give your hotel spaces a different character and quality of light, depending on which colour scheme you choose.

## Ein Frühlingsblatt zu jeder Jahreszeit

„Dandy“ greift das jahrtausendealte Fischgrätmuster auf, das die Designer von Balsan mit farbigen Akzenten untermalt haben, um dem Stil des Musters mehr Dynamik zu verleihen. Eleganz, Schlichtheit und Komfort sind die Kernbegriffe, die diesen mit viel Takt neu interpretierten Klassiker umschreiben. Je nachdem, für welche Farbgestaltung Sie sich entscheiden, verleiht dieser Veloursteppichboden mit Fischgrätmuster Ihren Räumen einen unterschiedlichen Charakter und verschiedene Helligkeitsniveaus.

Eternel 180



Amour 570



Havane 660



Jasmin 720



# Dandy

STANDARD

**RACCORD TECHNIQUE**  
Technical repeat  
Technische Verbindungen  
**XY = 9 cm x 135 cm**

**POSE CONSEILLÉE**  
Recommended fitting  
Empfohlene Verlegung  
**MEASURE & JOIN** (p 95)



4 m



DANDY - Eternel 180

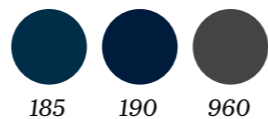

185 190 960

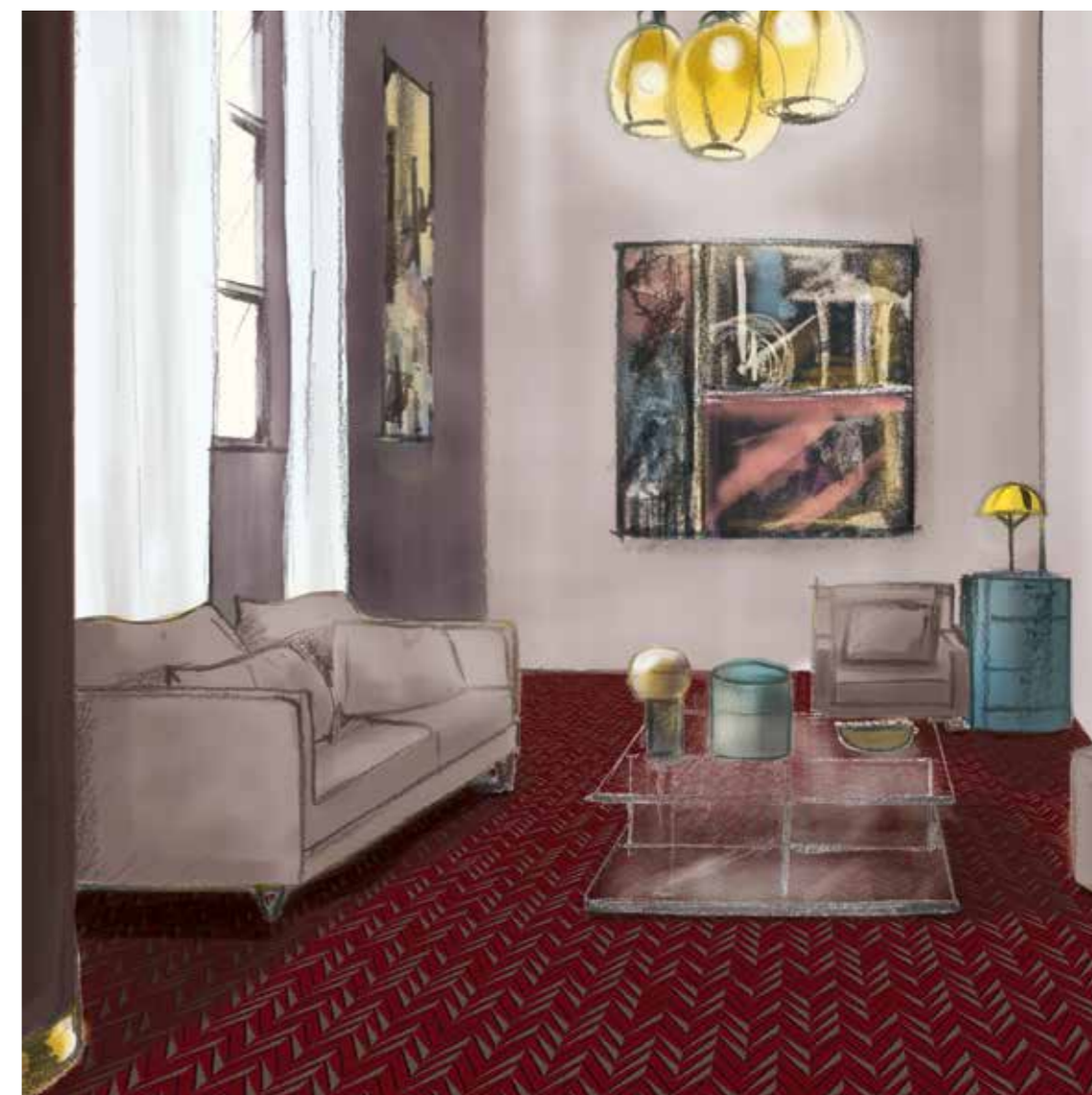

DANDY - Amour 570

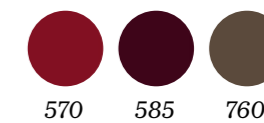

570 585 760



# Dandy

STANDARD

STANDARD



DANDY - Havane 660

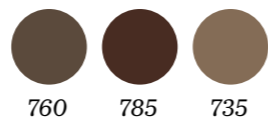

760 785 735



DANDY - Jasmin 720



710 730 610

STANDARD

CUSTOM

TECHNICS

# Flore

STANDARD

## En souvenir de la toile de Jouy

Inspiré de la toile de Jouy, classiquement connu des arts décoratifs français, le motif Flore se présente comme une fresque de fleurs géantes, délicates comme une gravure ancienne. La gamme chromatique de la ligne Flore s'éloigne des codes habituels de la toile de Jouy, ce qui contribue à sa modernité.

## Remembering Toile de Jouy

Inspired by Toile de Jouy, a world-famous classic from the French decorative arts world, the Flore motif is a fresco of giant flowers, as delicate as an ancient engraving. The Flore line's colour range is different from traditional Toile de Jouy designs, which contributes to its modernity.

## In Erinnerung an die Toile de Jouy

Inspiziert von dem weltberühmten Klassiker des französischen Kunstgewerbes, der Toile de Jouy, präsentiert sich das Flore-Muster als ein Fresko aus riesigen Blumen, so zart wie ein alter Kupferstich. Die Farbpalette der Flore-Linie weicht von den üblicherweise für die Toile de Jouy verwendeten Farbtönen ab, wodurch das Muster an Modernität gewinnt.

Orchidée 610



Camélia 580



Santal 740



Velvet 180



# Flore

STANDARD

**RACCORD TECHNIQUE**  
Technical repeat  
Technische Verbindungen  
XY = 396 cm x 280 cm

**POSE CONSEILLÉE**  
Recommended fitting  
Empfohlene Verlegung  
**LOOK & MATCH** (p 94)



4 m



FLORE - Orchidée 610

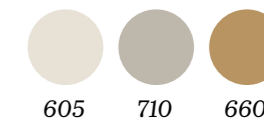

FLORE - Camélia 580

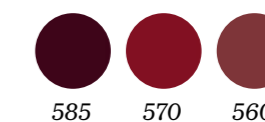



# Flore

STANDARD



FLORE - Santal 740

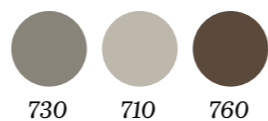

730 710 760



FLORE - Velvet 180



185 190 995

# Poésie

STANDARD

## Ondulation de nuances subtiles

Est-ce un drapé qui ondule ? Ou un effet de marbrures ? Des nuances de bois ou de matériaux précieux ? L'illusion est entretenue par le jeu subtil de nuances en ton sur ton qui taquinent la lumière. Telle est la « Poésie » de ce motif chic et onirique, dont le faux-uni ne livre pas ses secrets.

## Ripples in subtle shades

Is it a billowing draped effect or a marbled look? Are the shades reminiscent of wood or of precious materials? The illusion is maintained by the subtle interplay of tone-on-tone shades that tease the light. This is what makes this chic and dreamlike pattern so poetic. It may look plain, but it still has some well-kept secrets...

## Wellenförmige subtile Nuancen

Sich kräuselnde Falten oder ein Marmoreffekt? Holznuancen oder Farben edler Stoffe? Die Illusion wird durch das subtile Ton-in-Ton-Spiel der Farben, die das Licht kess herausfordern, aufrechterhalten. Dieses elegante und verträumte Muster, dessen Faux-Uni seine Geheimnisse nicht preisgibt, hat etwas Poetisches an sich.

Ambre 640



Nacre 710



Sauvage 780



Caviar 980



# Poésie

STANDARD

**RACCORD TECHNIQUE**  
Technical repeat  
Technische Verbindungen  
**XY = 198 cm x 348 cm**

**POSE CONSEILLÉE**  
Recommended fitting  
Empfohlene Verlegung  
**LOOK & MATCH** (p 94)

**JOINT LATÉRAL**  
Lateral seam  
Seitennaht  
**40 cm**

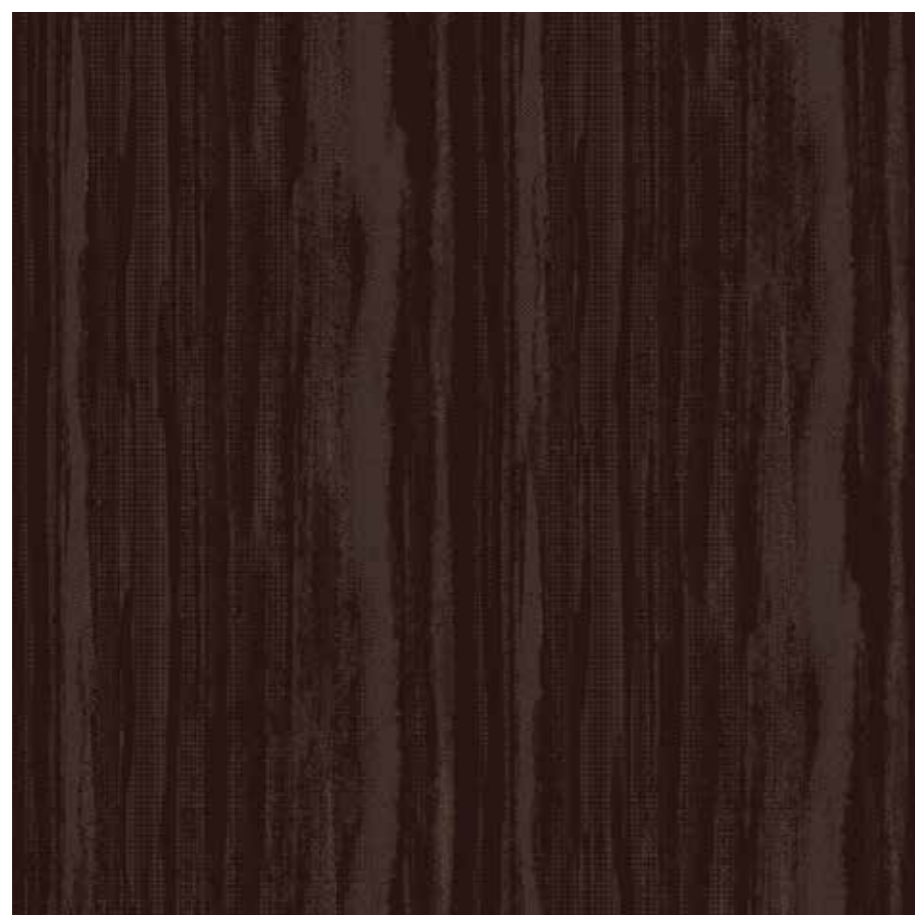

4 m



POÉSIE - Sauvage 780

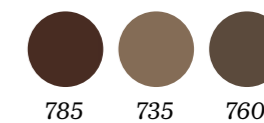

785 735 760



POÉSIE - Ambre 640

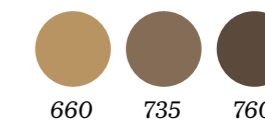

660 735 760

# Poésie

STANDARD

STANDARD



POÉSIE - Caviar 980



990 730 960



POÉSIE - Nacre 710



710 730 605

STANDARD

CUSTOM

TECHNICS

# Pompadour

STANDARD

## Un certain esprit « Marquise »

Inspiré d'une tapisserie de Versailles du temps de la marquise de Pompadour, le motif floral Pompadour est revisité avec un effet d'estompe qui le rend presque abstrait. Cette interprétation très contemporaine évoque néanmoins de manière subliminale le style de la célèbre favorite de Louis XV, qui éprouvait pour les arts et la décoration une grande passion.

## A certain aristocratic feel

Inspired by a Versailles tapestry from the time of Madame de Pompadour, the floral motif of the Pompadour pile carpet is given a twist using a blended effect that makes it almost abstract. This highly contemporary take nevertheless subliminally evokes the style of Louis XV's well-known favourite, who was passionate about art and interior design.

## Ein gewisser „Marquise-Stil“

Das florale von einem Versailler Wandteppich aus der Zeit der Marquise de Pompadour inspirierte und neu interpretierte Muster des Veloursteppichbodens Pompadour weist einen Verwischungseffekt auf, der es fast abstrakt aussehen lässt. Diese sehr zeitgemäße Interpretation erscheint dennoch unterschwellig als ein Anklang an den Stil der berühmten Favoritin Ludwig XV., die eine große Leidenschaft für die bildende und dekorative Kunst hegte.

Candide 620

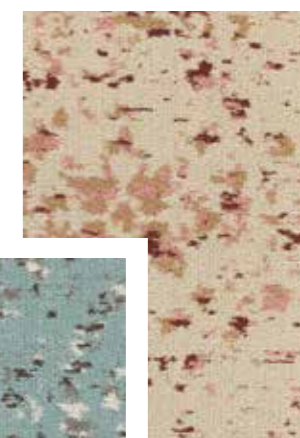

Céladon 230



# Pompadour

STANDARD

RACCORD TECHNIQUE	POSE CONSEILLÉE	JOINT LATÉRAL	JOINT DE TÊTE
Technical repeat	Recommended fitting	Lateral seam	Head seam
Technische Verbindungen	Empfohlene Verlegung	Seitennaht	Kopfnaht
<b>XY = 396 cm x 220 cm</b>	<b>LOOK &amp; MATCH</b> (p 94)	<b>40 cm</b>	<b>40 cm</b>



4 m



POMPADOUR - Céladon 230

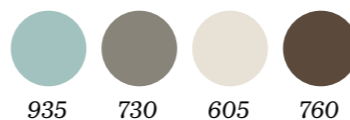

POMPADOUR - Candide 620

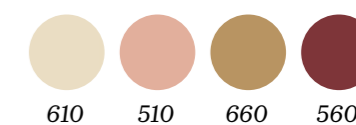

# Romance

STANDARD

## *Comme des faïences patinées*

Romance s'inspire des carreaux colorés de la péninsule ibérique et du nord de la France pour habiller les sols de votre hôtel d'une note décorative. Les motifs en volutes s'assemblent et se répètent pour former un effet de pavage patiné, dont certains détails donnent l'impression d'avoir été effacés au fil du temps.

## *Like weathered earthenware*

Romance, inspired by the colourful tiles of the Iberian Peninsula and Northern France, adds a decorative touch to your hotel floors. The repetitive scroll patterns come together to create a weathered paving effect, some details of which appear to have worn away over time.

## *Wie Fliesen mit Patina*

Romance ist von den farnefrohen Fliesen der Iberischen Halbinsel und des Nordens Frankreichs inspiriert und verleiht Ihren Hotelböden eine dekorative Note. Die spiralförmigen Muster fügen sich ineinander und wiederholen sich, sodass ein Effekt von verwittertem Pflasterstein entsteht, auf dem einige Details wie von der Zeit ausradiert scheinen.

### Grenade 580

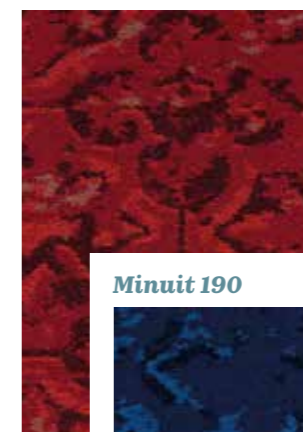

### Satin 710

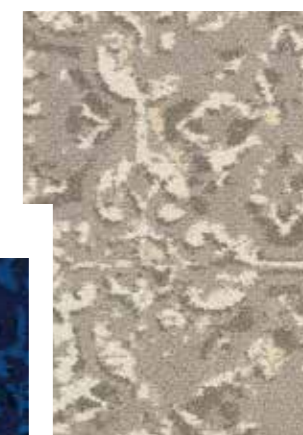

### Minuit 190



# Romance

STANDARD

**RACCORD TECHNIQUE**

Technical repeat  
Technische Verbindungen  
**XY = 24 cm x 24 cm**

**POSE CONSEILLÉE**

Recommended fitting  
Empfohlene Verlegung  
**LOOK & MATCH (p 94)**

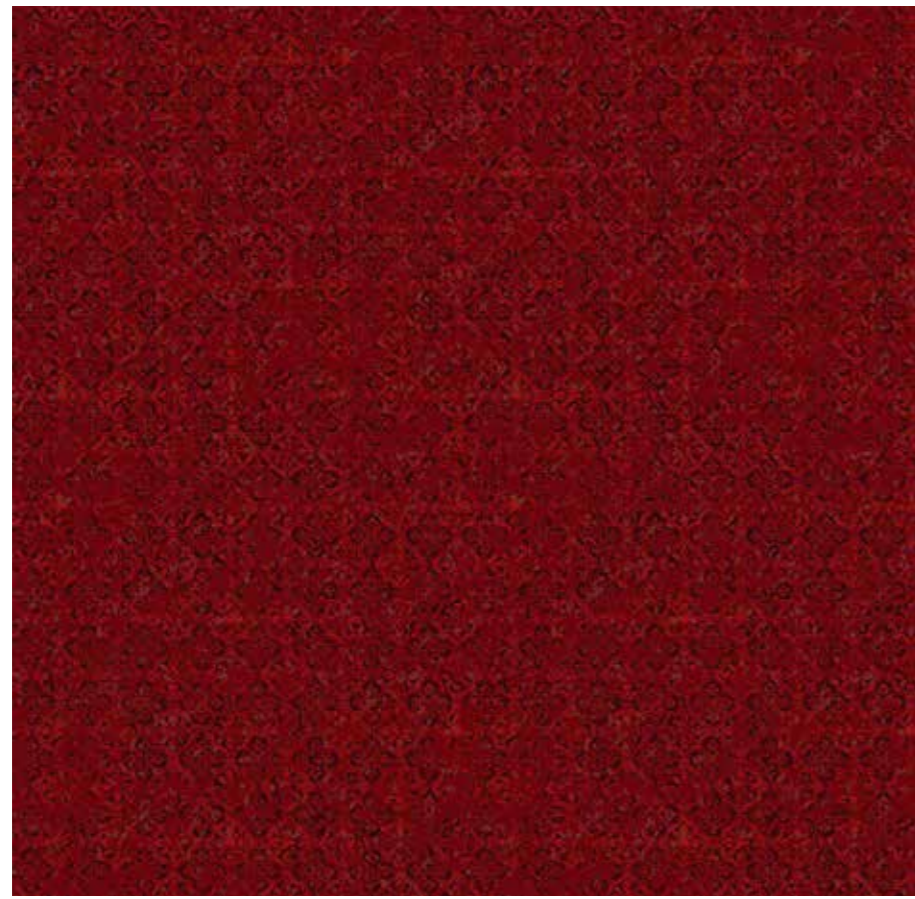

4 m

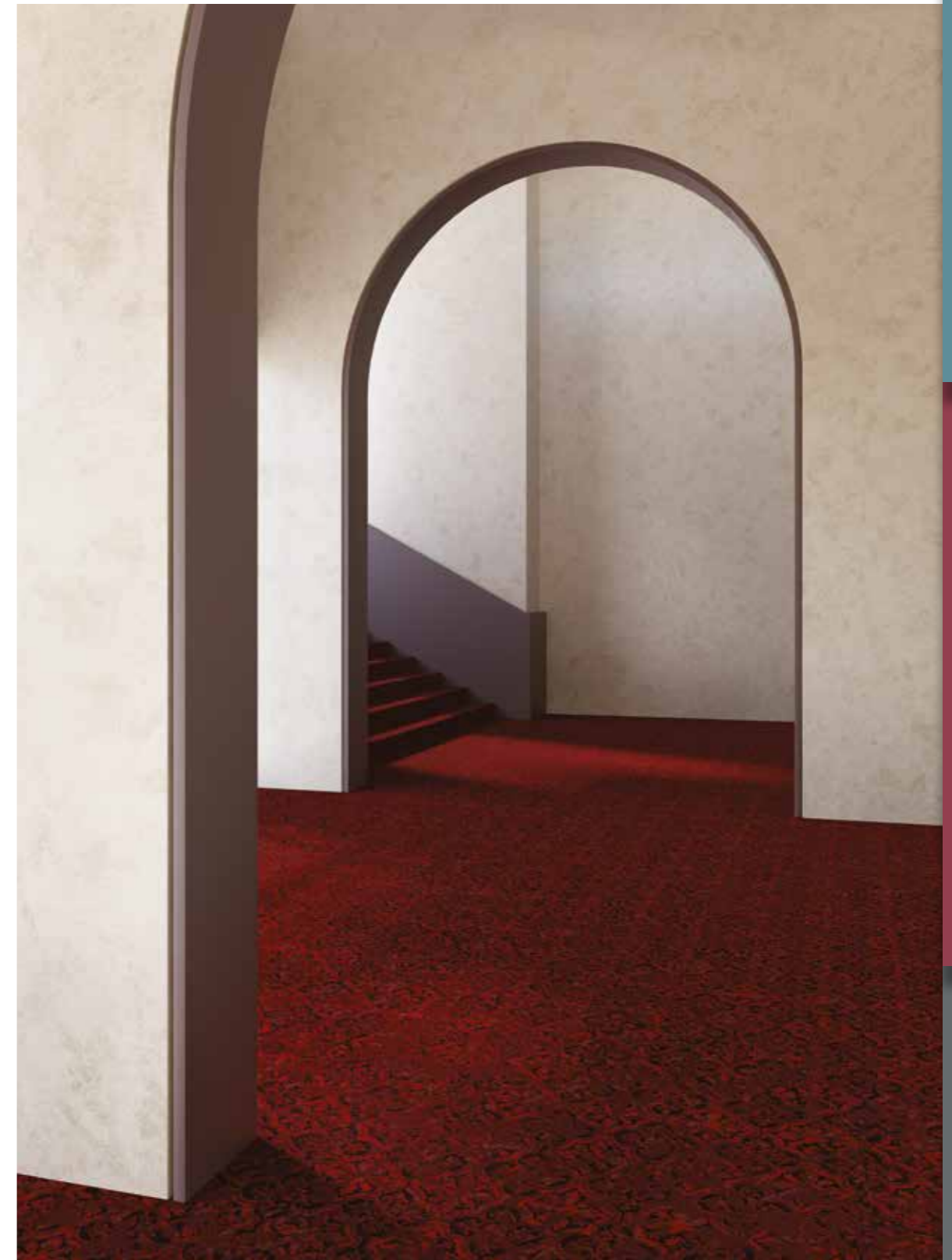

ROMANCE - Grenade 580





# Romance

STANDARD



ROMANCE - Minuit 190

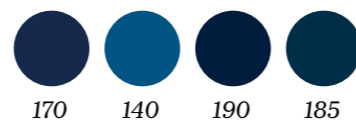

170 140 190 185

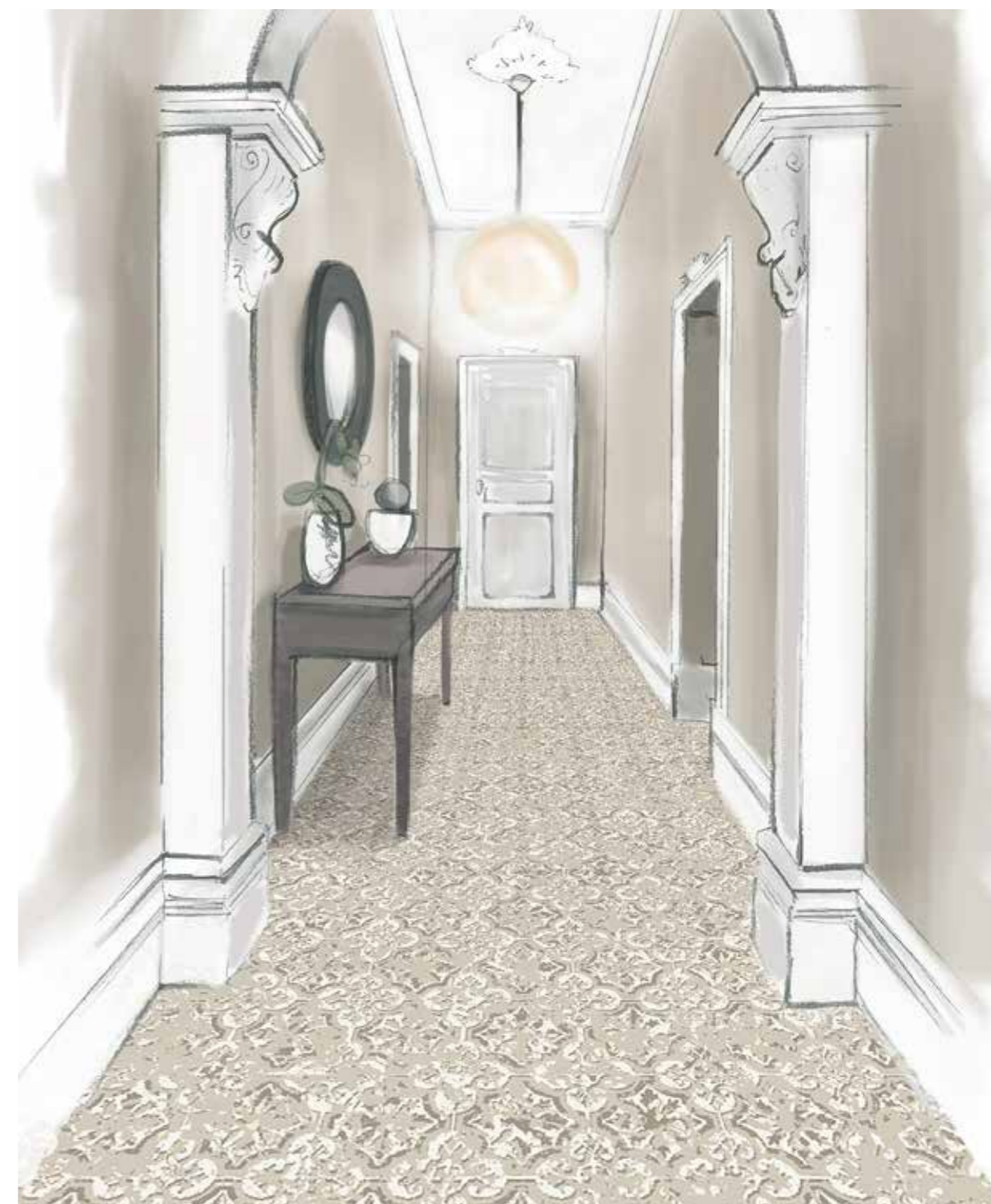

ROMANCE - Satin 710

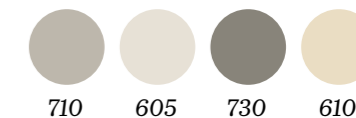

710 605 730 610

# Smart

STANDARD

## Hommage à l'Art Déco

Ce petit motif écaille qui se répète ad libitum évoque le style Art Déco tout en le dépouillant de son emphase. On pense par exemple à la flèche de la tour Chrysler à New York, sommet de l'époque Modern Style, avec ses arches étincelantes superposées, ou aux motifs en écaille ou en éventail des tapis des Années 30. Mais ici, le dessin est suggéré, épuré à l'extrême pour offrir au regard une sensation de simplicité et d'élégance intemporelle.

## A subtle evocation of the unforgettable 1930s style

The repeating small scale-like pattern subtly evokes Art Deco style without making it the focus. It is reminiscent of the spire of the Chrysler Building in New York – the pinnacle of the Modern Style era – with its shining overlapping arches, or the scale and fan patterns adorning 1930s carpets. But here, the design is simply suggested, pared down as far as possible to create a look that is simple yet timeless elegant.

## Eine subtile Anspielung an den unvergesslichen Stil der 1930er-Jahre

Das kleinformatige Schuppenmuster, das sich ad libitum wiederholt, erinnert an den Art-déco-Stil. Wenn wir Art déco hören, kommt uns das auf dem Höhepunkt der Ära des Style Moderne erbaute New Yorker Chrysler Building ebenso in den Sinn wie die Schildpatt- und Fächer motive der Teppiche der 1930er-Jahre. Hier jedoch wird das Motiv nur angedeutet. Es ist auf das Wesentliche reduziert, um auf den ersten Blick ein Gefühl von Schlichtheit und zeitloser Eleganz zu vermitteln.

Roméo 190



Poudre 520



Passion 580

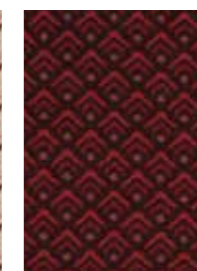

Vanille 610



Délicat 640



Bergamote 740



Narcisse 950

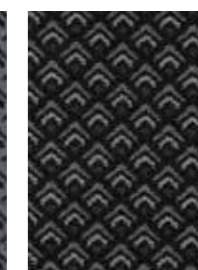

Blackjack 990

# Smart

STANDARD

**RACCORD TECHNIQUE**  
 Technical repeat  
 Technische Verbindungen  
**XY = 6 cm x 5 cm**

**POSE CONSEILLÉE**  
 Recommended fitting  
 Empfohlene Verlegung  
**MEASURE & JOIN** (p 95)

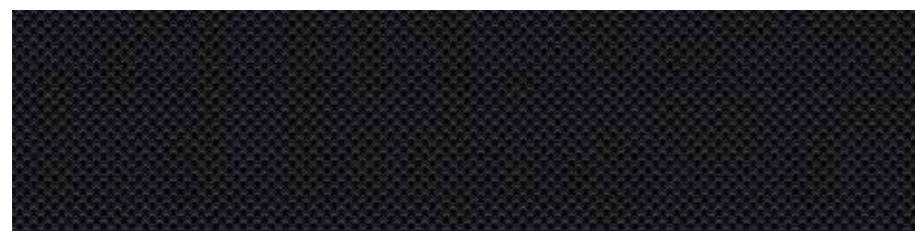

4 m



VISION OF  
*elegance*

**SMART - Roméo 190**

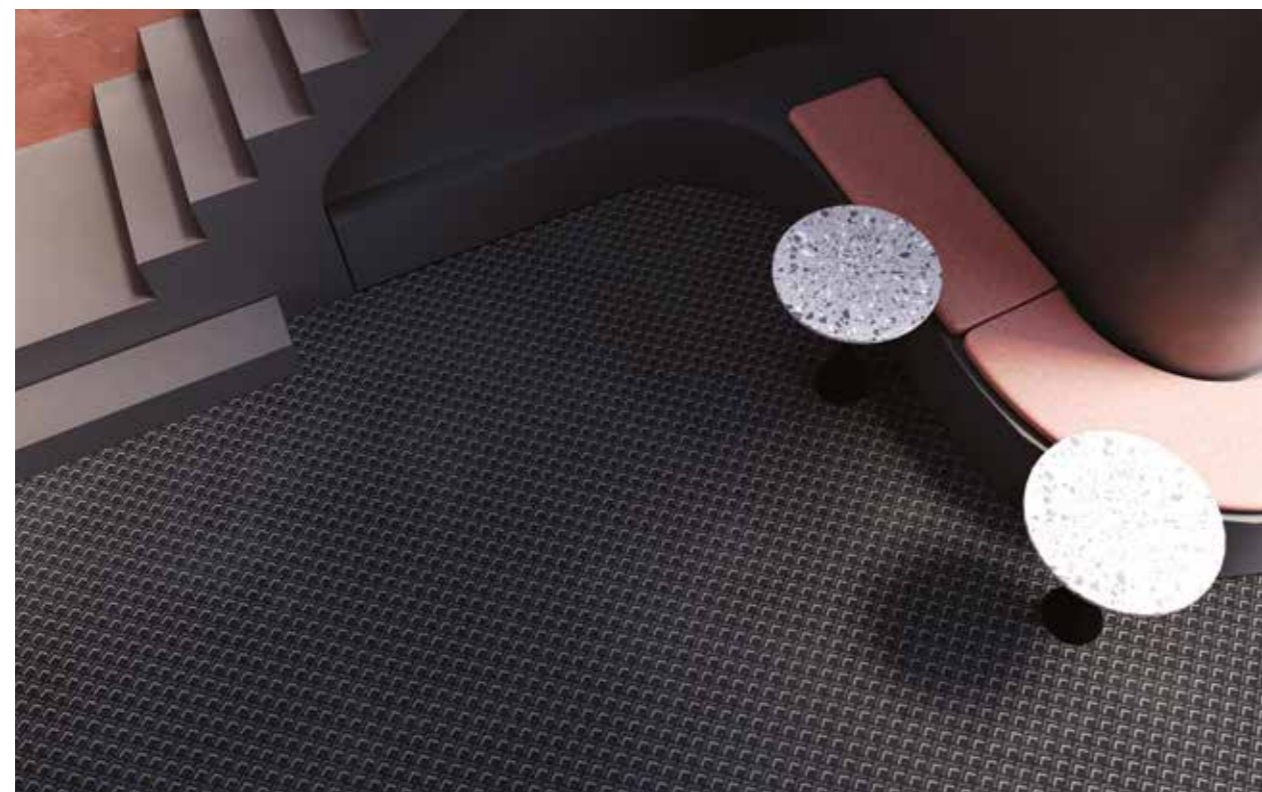
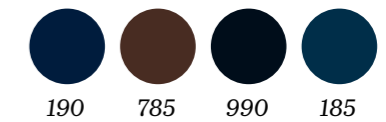

**SMART - BlackJack 990**

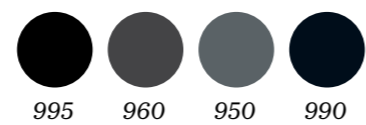

**SMART - Passion 580**

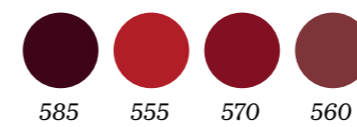

# Smart

STANDARD



SMART - Poudre 520

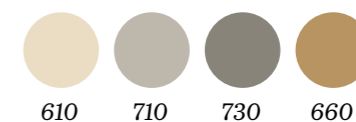
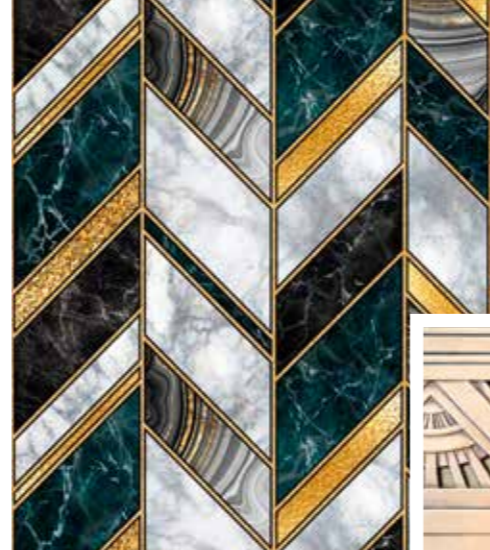
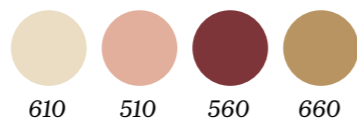

SMART - Vanille 610



# Smart

STANDARD



SMART - Délicat 640



VISION OF elegance



SMART - Bergamote 740

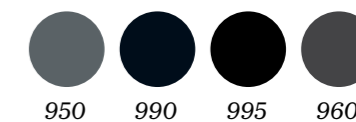

SMART - Narcisse 950



VISION OF  
*elegance*

**CUSTOM**

**DES DESSINS À L'INFINI...**

Nouvelles inspirations, nouvelles tendances, nouvelles associations... La collection d'exception Vision of Elegance s'enrichit de 15 dessins supplémentaires, personnalisables\* à volonté par la combinaison des couleurs. La collection standard peut être recolorée, elle aussi, selon vos envies\*. Notre bureau de dessin se tient disponible pour adapter votre dessin personnalisé à la configuration de votre espace, afin de limiter les pertes. Ces motifs sont particulièrement adaptés à l'aménagement intérieur des hôtels ou des bateaux de croisière.

\*fabrication spéciale

**ENDLESS DESIGN POSSIBILITIES...**

*New inspirations, new trends, new combinations... The exceptional Vision of Elegance collection is expanding with 15 additional designs which you can freely customise\* with different colour combinations. Our design office is available to help adapt your custom design to the layout of your space in order to minimise wastage. These patterns are particularly well suited for use in hotels and cruise ships.*

\*specially manufactured

**EIN FÜLLE VON DESIGNS...**

*Neue Inspirationen, neue Trends, neue Kompositionen: Die Ausnahmekollektion Vision of Elegance wird um 15 neue Designs erweitert, die dank unterschiedlicher Farbkombinationen beliebig personalisierbar\* sind. Auch die Standard-Kollektion ist auf Wunsch hin in neuen Farben erhältlich\*. Unsere Designabteilung steht Ihnen zur Verfügung, um Ihr individuelles Muster an die Gegebenheiten Ihrer Räumlichkeiten anzupassen und so den Verschnitt möglichst gering zu halten. Die Bodenbeläge eignen sich hervorragend für die Inneneinrichtung von Hotels und Kreuzfahrtschiffen.*

\*Sonderanfertigung

**15 NOUVEAUX DESSINS** ..... p 60  
15 New designs / 15 neue Designs

**DESSINS RECOLORES** ..... p 80  
Recoloured designs / Designs in neuen Farben

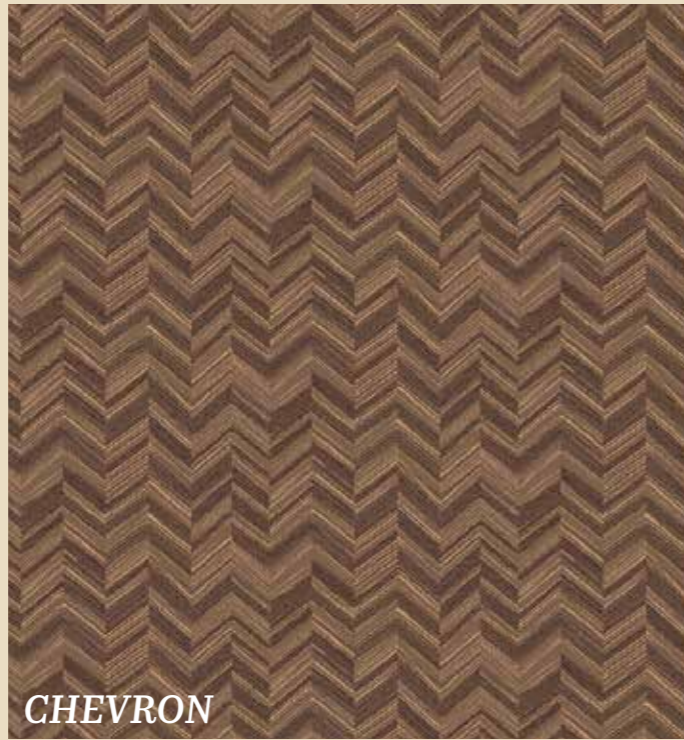

CHEVRON



PATINE

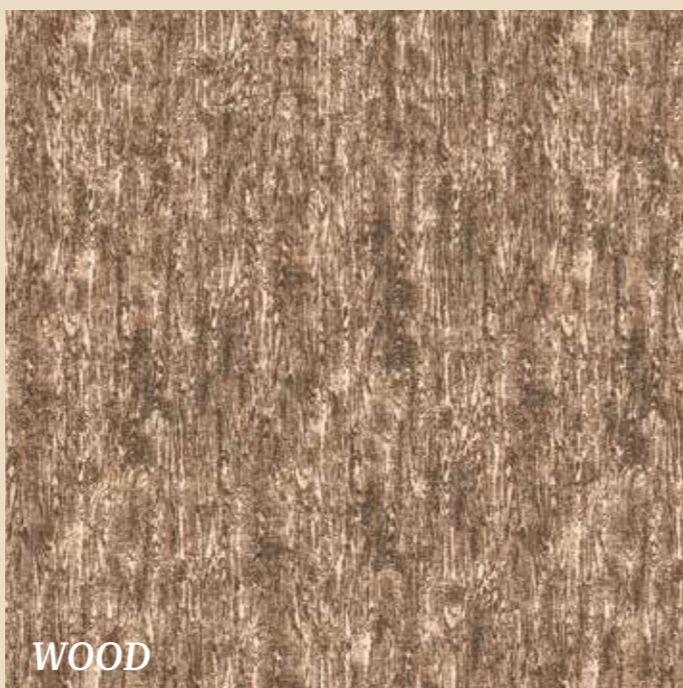
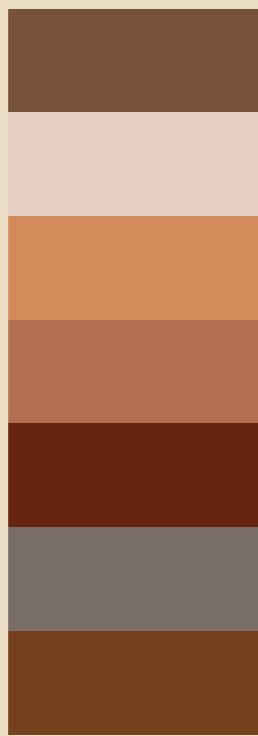

WOOD



CUSTOM

TECHNICS



>400  
m<sup>2</sup>/sqm  
54 couleurs  
colors  
Farben

**CHEVRON**

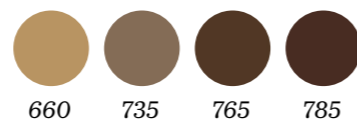

**RACCORD TECHNIQUE**  
Technical repeat  
Technische Verbindungen  
XY = 198 cm x 75 cm

**WOOD**

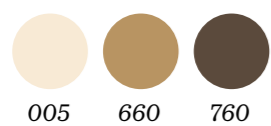

**RACCORD TECHNIQUE**  
Technical repeat  
Technische Verbindungen  
XY = 396 cm x 373 cm



VISION OF  
*elegance*

**PATINE**

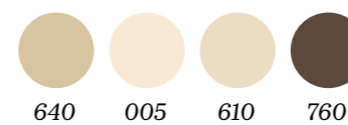

**RACCORD TECHNIQUE**  
Technical repeat  
Technische Verbindungen  
XY = 396 cm x 355 cm





**MOIRE**



**SPRING**

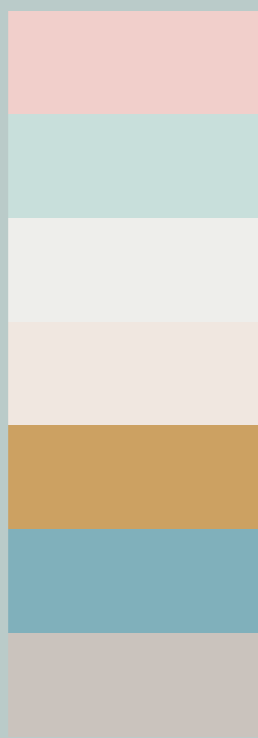

**PRISME**



CUSTOM

CUSTOM

TECHNICS



**MOIRE**

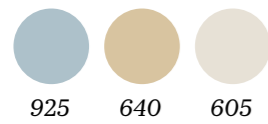

**RACCORD TECHNIQUE**  
 Technical repeat  
 Technische Verbindungen  
**XY = 396 cm x 462 cm**



**PRISME**

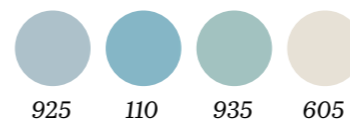

**RACCORD TECHNIQUE**  
 Technical repeat  
 Technische Verbindungen  
**XY = 396 cm x 391 cm**



**SPRING**

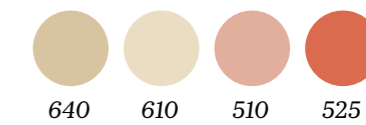

**RACCORD TECHNIQUE**  
 Technical repeat  
 Technische Verbindungen  
**XY = 396 cm x 540 cm**



MIX



ORNEMENT

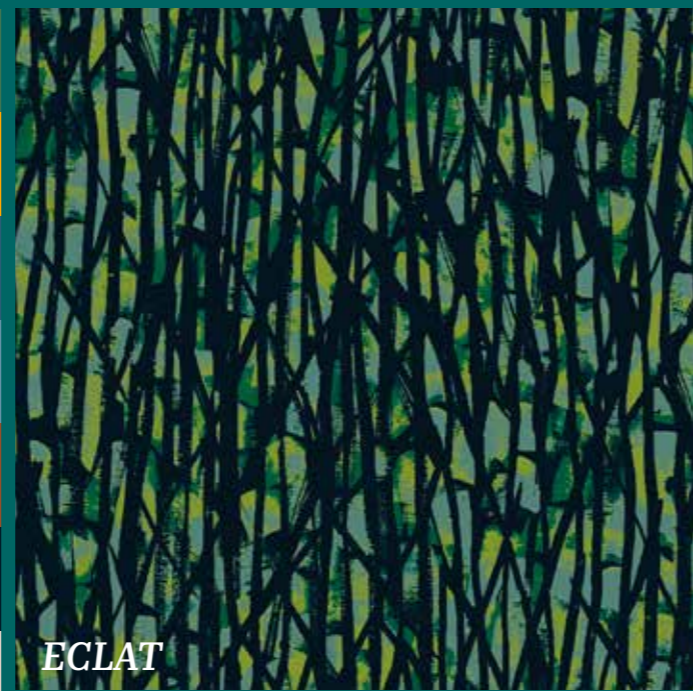

ECLAT



CUSTOM

CUSTOM

TECHNICS

>400  
m<sup>2</sup>/sqm  
54  
couleurs  
colors  
Farben

MIX



**RACCORD TECHNIQUE**  
Technical repeat  
Technische Verbindungen  
XY = 198 cm x 150 cm



ECLAT

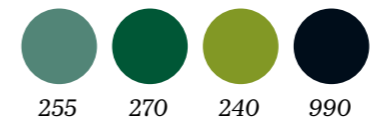

**RACCORD TECHNIQUE**  
Technical repeat  
Technische Verbindungen  
XY = 396 cm x 256 cm

CUSTOM

CUSTOM

TECHNICS



ORNEMENT

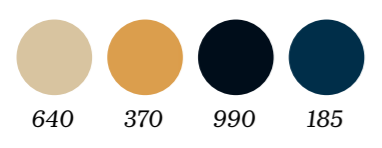

**RACCORD TECHNIQUE**  
Technical repeat  
Technische Verbindungen  
XY = 396 cm x 270 cm

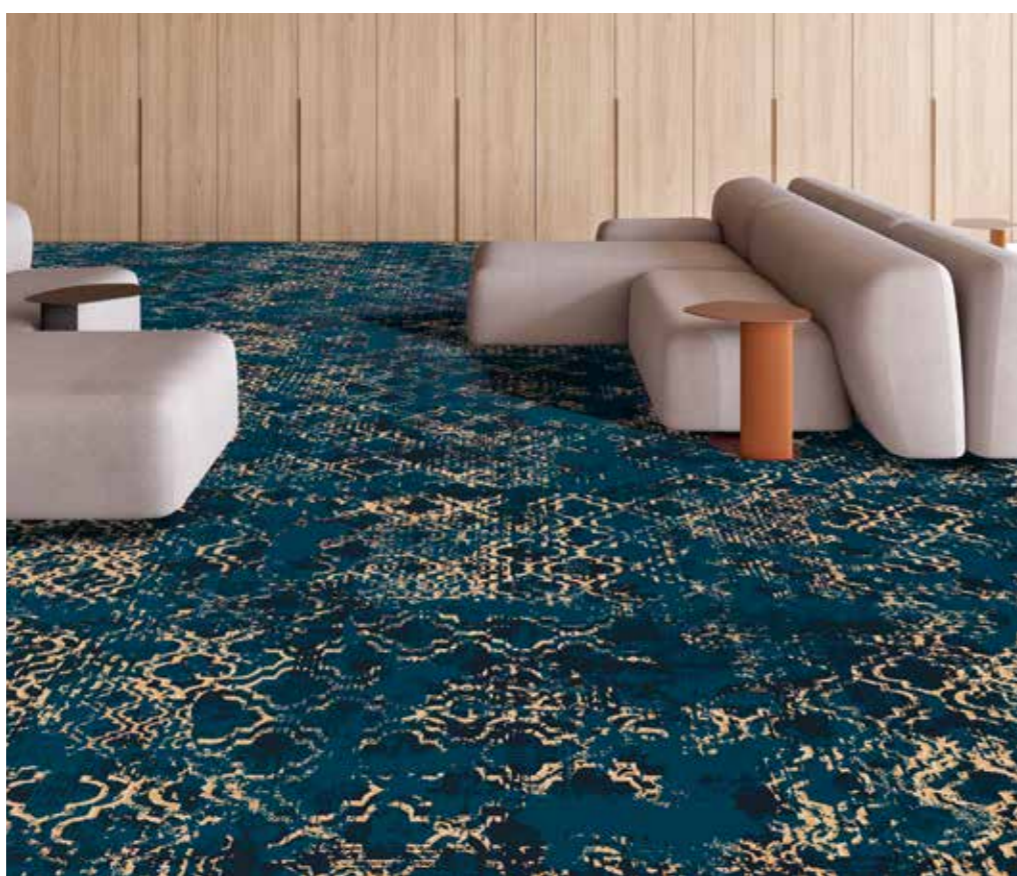

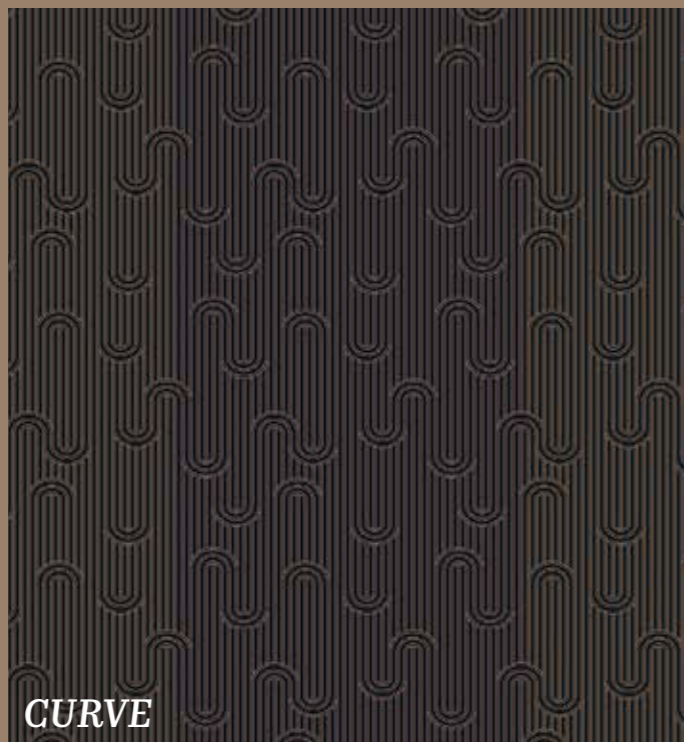

**CURVE**



**ROSES**



**ARDENT**



CUSTOM  
CUSTOM / CUSTOM

CUSTOM  
CUSTOM / CUSTOM

TECHNIQUE  
TECHNIQUE / TECHNIQUE



>400  
m<sup>2</sup>/sqm  
54  
couleurs  
colors  
Farben

**CURVE**

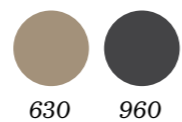

**RACCORD TECHNIQUE**  
Technical repeat  
Technische Verbindungen  
**XY = 100 cm x 100 cm**

VISION OF  
*elegance*



**ARDENT**

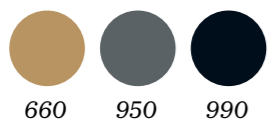

**RACCORD TECHNIQUE**  
Technical repeat  
Technische Verbindungen  
**XY = 396 cm x 348 cm**



**ROSES**

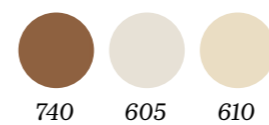

**RACCORD TECHNIQUE**  
Technical repeat  
Technische Verbindungen  
**XY = 396 cm x 320 cm**



DEDALE



BAUHAUS

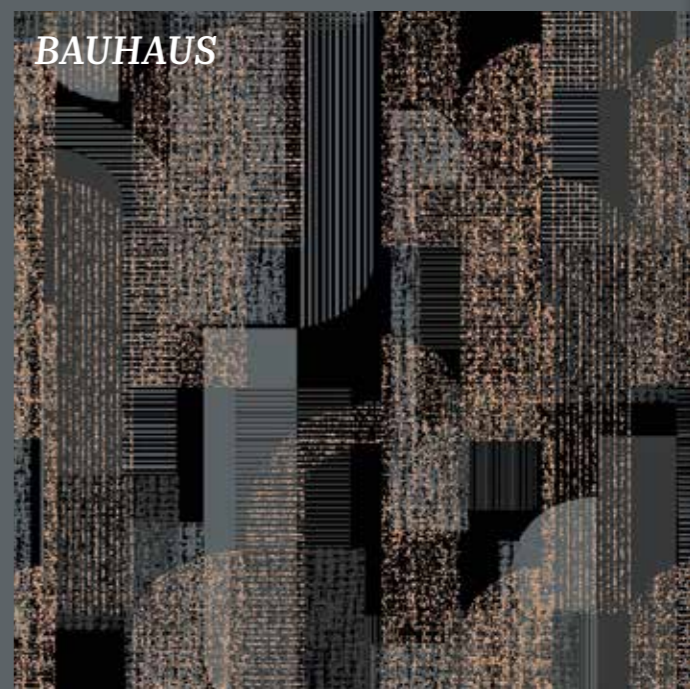

BRUSH



CUSTOM

CUSTOM

TECHNICS



**BAUHAUS**

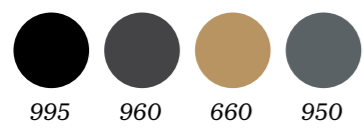

**RACCORD TECHNIQUE**  
 Technical repeat  
 Technische Verbindungen  
**XY = 396 cm x 412 cm**



**DEDALE**

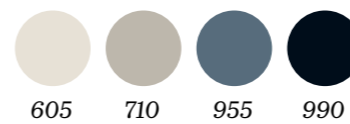

**RACCORD TECHNIQUE**  
 Technical repeat  
 Technische Verbindungen  
**XY = 396 cm x 235 cm**

VISION OF  
 elegance



**BRUSH**

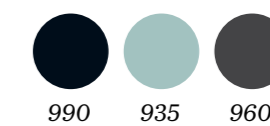

**RACCORD TECHNIQUE**  
 Technical repeat  
 Technische Verbindungen  
**XY = 396 cm x 355 cm**



Laissez-vous inspirer  
par la couleur...

Be inspired by our colours...

Lassen Sie sich von der Farbe inspirieren ...

>400  
m<sup>2</sup>/sqm  
54 couleurs  
colors  
Farben



**BOHEME** (p 18)

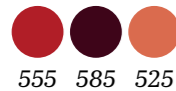

555 585 525



**CURVE** (p 74)



585 555



**ROSES** (p 75)

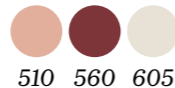

510 560 605



**MOIRE** (p 66)

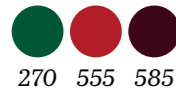

270 555 585

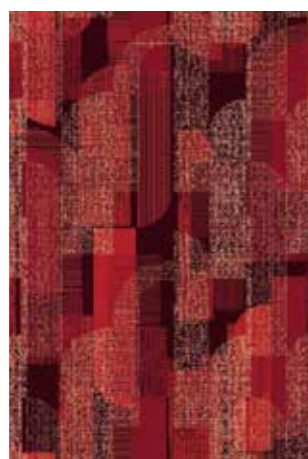

**BAUHAUS** (p 78)



585 660 570 555



**DEDALE** (p 79)

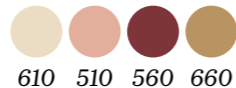

610 510 560 660



**SMART** (p 50)



585 740 570 560



**POMPADOUR** (p 40)

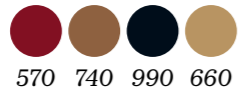

570 740 990 660

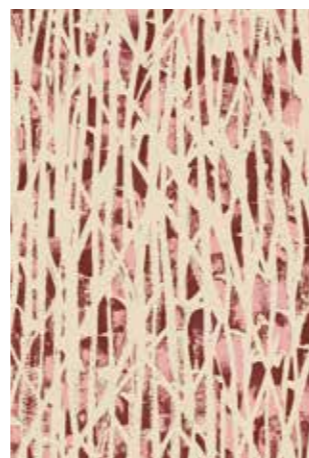

**ECLAT** (p 71)

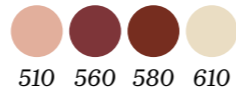

510 560 580 610

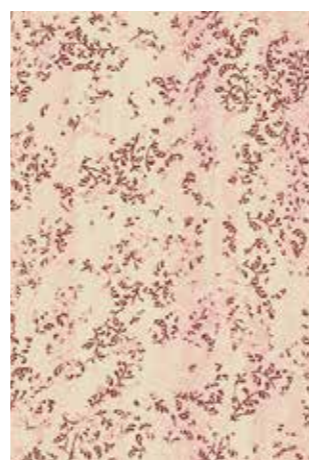

**BOHEME** (p 18)

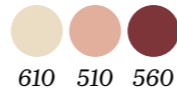

610 510 560



**BRUSH** (p 79)

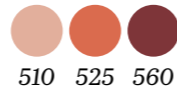

510 525 560



**ROMANCE** (p 44)



605 660 640 610

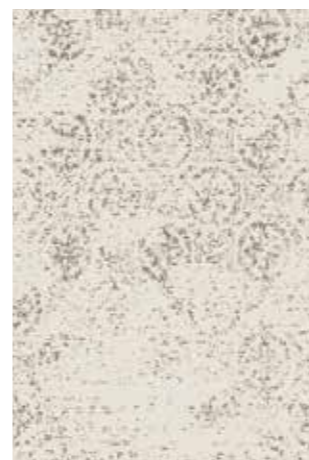

**POMPADOUR** (p 40)



605 730 610 710



**ORNEMENT** (p 70)

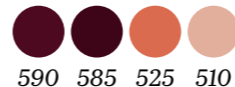

590 585 525 510

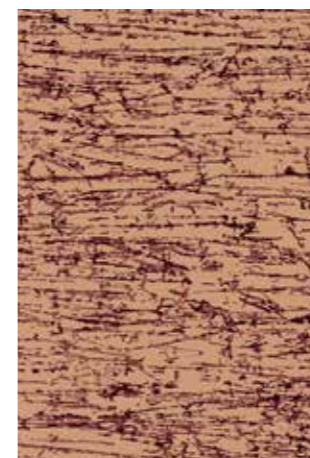

**ARDENT** (p 74)

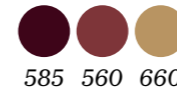

585 560 660



**WOOD** (p 62)

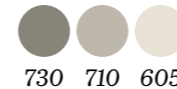

730 710 605



**CHEVRON** (p 62)

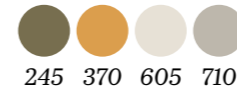

245 370 605 710



**MOIRE** (p 66)

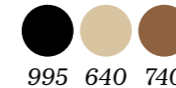

995 640 740



**MIX** (p 70)

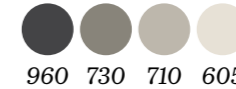

960 730 710 605

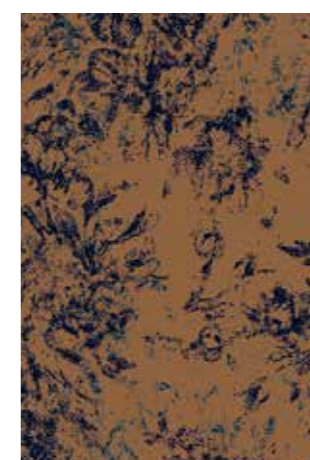

**FLORE** (p 28)

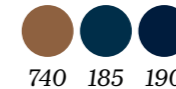

740 185 190



**POESIE** (p 34)

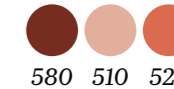

580 510 525



**WOOD** (p 62)



785 760 735



**FLORE** (p 28)



990 960 640



**PRISME** (p 67)



990 995 960 950



**POESIE** (p 34)



990 955 925

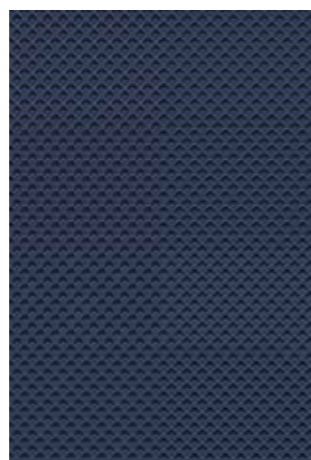

**SMART** (p 50)



960 150 190 140



**PATINE** (p 63)



960 760 995



**CHEVRON** (p 62)



995 735 960 730

>400  
m<sup>2</sup>/sqm  
54 couleurs  
colors  
Farben

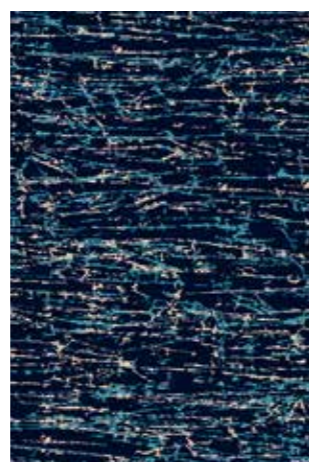

**ARDENT** (p 74)



115 640 190



**ROSES** (p 75)



865 190 920

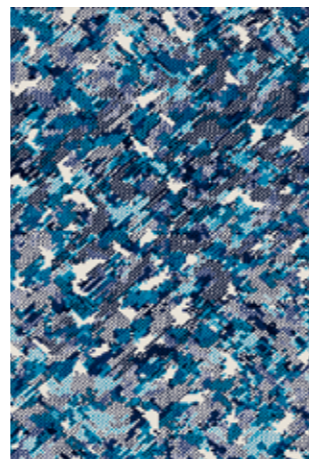

**MIX** (p 70)



170 135 190 605



**DANDY** (p 22)



920 950 910



**SPRING** (p 67)



115 185 920 910



**ECLAT** (p 71)



760 730 710 605



**DEDALE** (p 79)



605 710 955 990



**ORNEMENT** (p 70)



920 910 990 960



**CURVE** (p 74)



285 255



**BRUSH** (p 79)



605 950 990



**ROMANCE** (p 44)



910 185 255 925



**DANDY** (p 22)



990 960 270



**BAUHAUS** (p 78)



285 640 255 270



**PRISME** (p 67)



730 935 660 605



**SPRING** (p 67)



240 340 610 005



**PATINE** (p 63)



270 255 285 240



**SPRING** (p 67)



851 876 826 821



**POESIE** (p 34)



831 826 876



**BAUHAUS** (p 78)



560 826 881 585



**CURVE** (p 74)



881 826



**PATINE** (p 63)



590 570 560 791



**DEDALE** (p 79)



716 876 826 512



**ARDENT** (p 74)



531 596 556



**ROSES** (p 75)



990 556 531

>800  
m<sup>2</sup>/sqm  
156 couleurs  
colors  
Farben

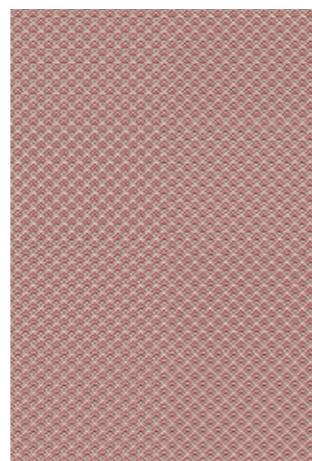

**SMART** (p 50)



611 560 570 253

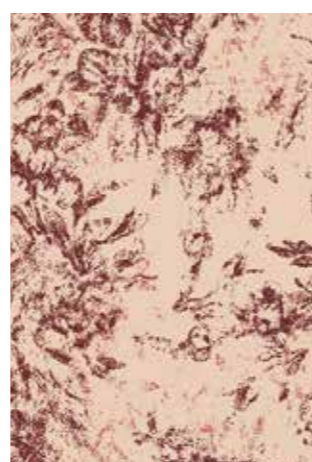

**FLORE** (p 28)



628 521 581



**WOOD** (p 62)



826 821 710



**ORNEMENT** (p 70)



510 611 580 761



**MOIRE** (p 66)



560 512 611



**PRISME** (p 67)



156 108 196 821



**BOHEME** (p 18)



605 656 766

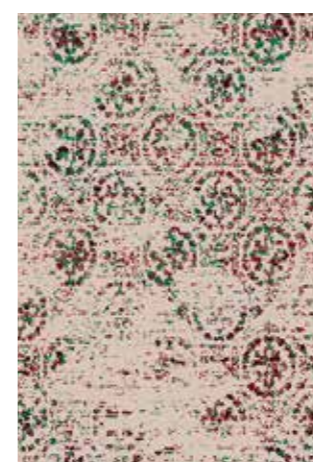

**POMPADOUR** (p 40)



611 261 585 570



**ECLAT** (p 71)



108 956 961 960



**ROMANCE** (p 44)



922 961 926 611

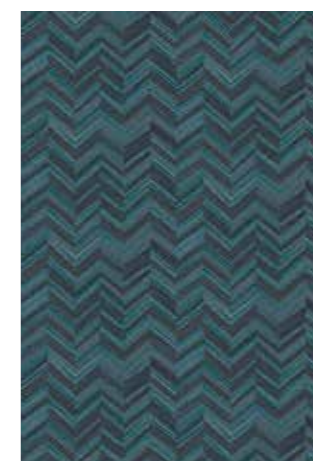

**CHEVRON** (p 62)



796 925 968 188

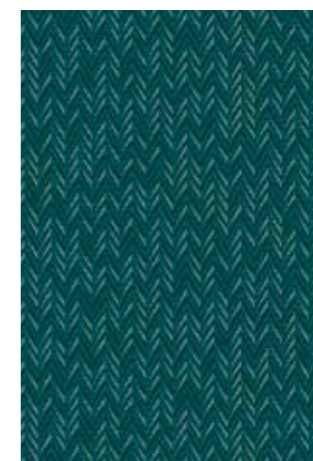

**DANDY** (p 22)



167 285 132



**MIX** (p 70)



185 135 115 140



**POMPADOUR** (p 40)



190 133 156 118

>800  
m<sup>2</sup>/sqm  
156 couleurs  
colors  
Farben



**BOHEME** (p 18)  
381 370 740



**DANDY** (p 22)  
251 240 221



**CHEVRON** (p 62)  
774 381 003 351



**ORNEMENT** (p 70)  
270 291 660 255



**SPRING** (p 67)  
605 710 716 660

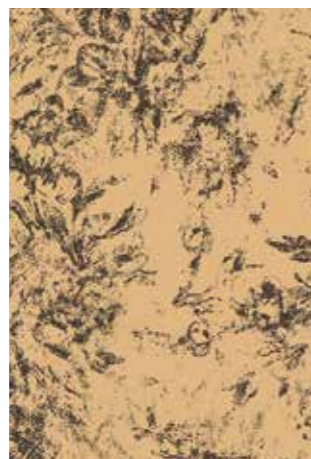

**FLORE** (p 28)  
663 245 780

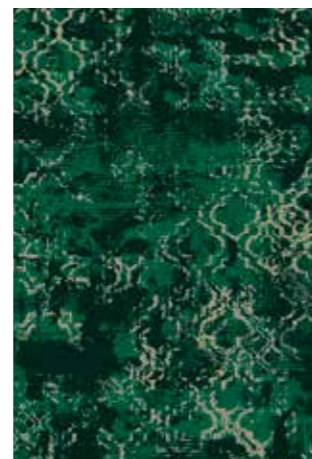

**BRUSH** (p 79)  
255 188 226



**MOIRE** (p 66)  
560 255 291



**DEDALE** (p 79)  
956 188 926 710



**ECLAT** (p 71)  
255 291 185 460



**PATINE** (p 63)  
291 255 974 735



**BAUHAUS** (p 78)  
735 611 188 778



**MIX** (p 70)  
990 270 740 640



**WOOD** (p 62)  
966 922 006



**ROMANCE** (p 44)  
560 253 188 132



**ROSES** (p 75)  
611 780 766



**POESIE** (p 34)  
956 926 185



**ARDENT** (p 74)  
255 990 188

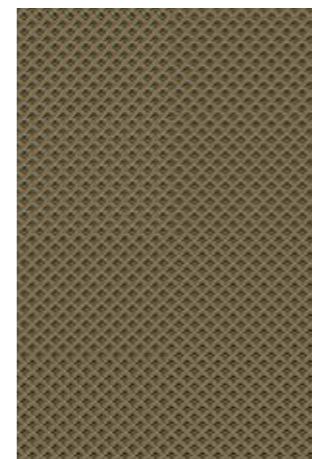

**SMART** (p 50)  
740 132 291 261

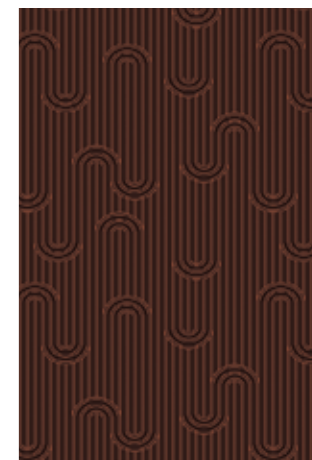

**CURVE** (p 74)  
785 761

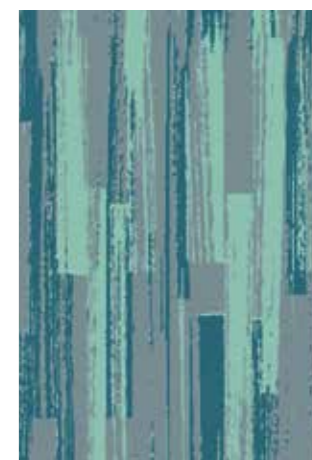

**BRUSH** (p 79)  
956 935 926

# Expertise & Technology

## INNOVATION ET HAUTE PERFORMANCE

La collection Vision of Elegance, bénéficie d'une technologie d'avant-garde, CYP-Colortec+, qui assure une précision graphique, un confort exceptionnel et une profondeur de couleurs incomparable. Cette nouvelle technologie permet une créativité sans limite: la possibilité de créer des dessins est infinie et permet une variété d'harmonies, avec une très large palette de couleurs.

Vision of Elegance, sur un support de tuft en velours de 1 250 gm<sup>2</sup> est composée d'une fibre 100 % Polyamide teinte dans la masse qui offre une résistance optimale à la décoloration, aux UV, aux taches inopportunes et aux produits d'entretien, même les plus agressifs.

## INNOVATION AND HIGH PERFORMANCE

*The Vision of Elegance collection benefits from cutting-edge CYP-Colortec+ technology which ensures graphic precision, exceptional comfort and unrivalled colour depth. This new technology offers unlimited creativity, providing the freedom to create an infinite number of designs by playing around with a host of combinations and a wide range of different colours.*

*With a 1,250 g/m<sup>2</sup> tuft backing, the Vision of Elegance pile carpet collection is made from 100% polyamide solution-dyed fibre which is highly resistant to discolouration, UV rays, stains and even the most aggressive cleaning products.*



### Excellente robustesse

Highly durable  
Ausgezeichnete robustheit

Classement  
Rank  
Klassifizierung **33**

### Acoustique de très haut niveau

Excellent acoustics  
Optimale schalldämmung

$\Delta lw$  30 db,  $\alpha w$  0,25 (action back)  
 $\Delta lw$  36 db,  $\alpha w$  0,35 (confort +) (>1 000 m<sup>2</sup>)

### Classement feu

Fire classification  
Brandschutzklasse

**bfl-s1** collée sur ciment  
glued on cement  
verklebt auf zement

### IMO

Sur demande  
On demand  
Auf Anfrage

## INNOVATION UND HOCHLEISTUNG

Bei der Kollektion Vision of Elegance kommt die hochmoderne Technologie CYP-Colortec+ zum Einsatz, die für Mustergenauigkeit, außergewöhnlichen Komfort und intensive Farben sorgt. Dank der Technologie CYP-Colortec+ sind der Kreativität keine Grenzen mehr gesetzt. Die Möglichkeiten der Mustergestaltung sind nahezu unbegrenzt und eine breite Farbpalette erlaubt mannigfaltige Kombinationen.

Vision of Elegance besteht aus Veloursteppichböden mit einer Tuftvariante mit 1 250 g/m<sup>2</sup>, die aus 100% durchgefärbten Polyamidfasern bestehen. Sie zeichnen sich durch eine optimale Farbeständigkeit gegenüber UV-Strahlen aus, sind fleckenunempfindlich und selbst gegen die aggressivsten Reinigungsmittel beständig.



La technologie d'avant-garde, CYP-Colortec+, vous permet de créer des dessins à l'infini avec une richesse chromatique qui épouse toutes vos envies.

*Cutting-edge CYP-Colortec+ technology allows you to create an infinite number of designs with a richness of colour that meets all your desires.*

*Dank der Spitzentechnologie CYP-Colortec+ können Sie Ihren Wünschen entsprechend unzählige Muster in einer breiten Farbpalette kreieren.*

## CYP Colortec+

COMPUTER YARN PLACEMENT

**Avant-première en Europe !**  
*Premiere in Europe / Zum ersten Mal in Europa!*



**TECHNOLOGIE INTELLIGENTE**  
Smart technology  
Intelligente Technologie



**CRÉATION DE DESSINS A L'INFINI**  
Infinite design possibilities  
Unendliche Kreation von Mustern



**PRÉCISION DU MOTIF**  
Precise patterns  
Präzise Motive



**TRÈS LARGE PALETTE DE COULEURS\***  
Very wide colour palette\*  
Sehr grosse farbpalette\*



**ROBUSTESSE**  
Robustness  
Widerstands-Fähigkeit

\* 184 000 points / m<sup>2</sup> • 11,7 stitches / in<sup>2</sup>

Vous avez la possibilité de créer des tapis en standard ou sur mesure pour vos hôtels ou bateaux de croisière. Consultez-nous.

You can create standard or custom carpets for your hotels or cruise ships. Feel free to get in touch with us.

Sie haben die Möglichkeit, Teppiche als Standard- oder Maßanfertigung für Ihre Hotels oder Kreuzfahrtschiffe zu kreieren. Wir stehen Ihnen gerne bei Fragen zur Verfügung.



Design Abysses, Balsan

Design Spring, Balsan

Design Florens Orbis, Baptiste VANDAELE



# Mode d'emploi

HOW IT WORKS / GEBRAUCHSANWEISUNG

**1** **Choisissez votre dessin Vision of Elegance ou votre création**  
Choose your Vision of Elegance design or a design of your own  
Wählen Sie ein Vision of Elegance-Motiv oder ihr eigenes Design



**2** **Choisissez vos couleurs (jusqu'à 4 couleurs)**  
Choose your colours (up to 4 colours)  
Wählen Sie Ihre Farben (bis zu 4 Farben)

>400  
m<sup>2</sup>/sqm



**54** couleurs  
colors  
Farben

**SERVICE RAPIDE**  
Quick Service  
Schneller

>800  
m<sup>2</sup>/sqm



**156** couleurs  
colors  
Farben

L'équipe Design Balsan accompagne votre projet personnalisé. Testez vos créations sur notre design studio :  
Balsan Design team helps you with your personalized project. Try out your creations online :  
Das Balsan Design-Team unterstützt Ihr individuelles Projekt. Probieren Sie alle Ihre Kreationen aus :  
[www.balsan.com/personnalisation](http://www.balsan.com/personnalisation)

**3** **Votre choix**  
Your choice  
Ihre Wahl

**54** couleurs  
colors  
Farben



+



**156** couleurs  
colors  
Farben

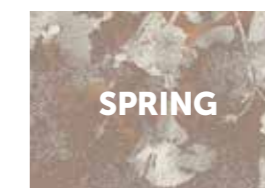

+



**4** **Obtenez votre création unique**  
Your unique creation  
Erhalten Sie ihren einmaligen individuellen Entwurf



**Avec l'outil COLOR VISION, créez vos designs les plus sophistiqués, avec une grande précision et un souci du détail.**

With the COLOR VISION tool, you can create sophisticated designs with a very high precision and attention to detail.

Erstellen Sie mit COLOR VISION box, Ihre anspruchsvollsten Designs mit hohe Präzision und Liebe zum Detail.

# Installation

## INSTALLATION / VERLEGUNG

En fonction de la typologie du dessin à raccorder, deux niveaux de raccordement sont à considérer : Look & Match et Measure & Join. La plupart des dessins de cette collection a été dessinée pour une pose Look and Match, limitant les pertes. Chaque projet est à adapter au lieu de pose avec l'aide de nos équipes.

According to the type of design to be joined, 2 levels of join should be considered Look & Match et Measure & Join. Most of the designs in this collection have been designed for a Look and Match layout, limiting losses. Our teams will help adapt each project to the place where the carpets are fitted.

Je nach Art des zu Verbindenden Designs ist eine der 2 Verbinde-Methoden anzuwenden : Look & Match et Measure & Join. Die meisten Muster dieser Kollektion wurden für ein Verlegen mit der Look-and-Match-Methode entworfen, wodurch Abfall durch Verschnitt begrenzt werden kann.

Jedes Projekt ist in Zusammenarbeit mit unseren Teams an den Ort, an dem der Teppichboden verlegt werden soll, anzupassen.

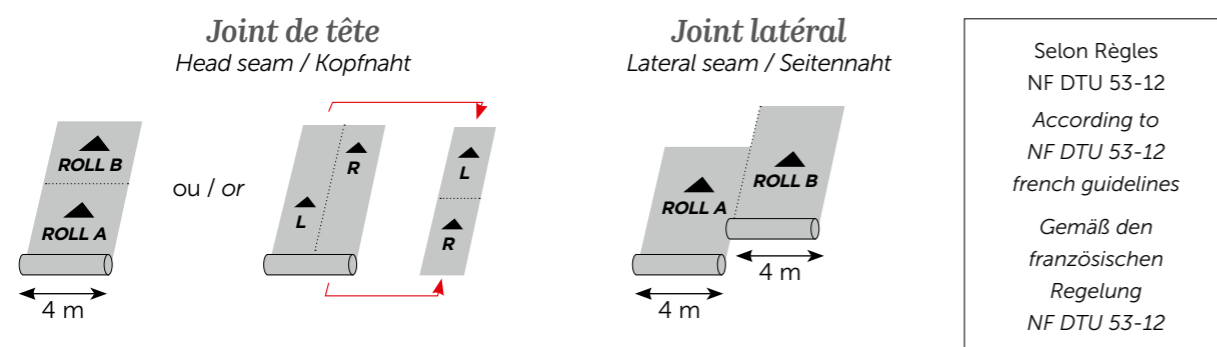

## LOOK & MATCH

**Le raccordement se fait logiquement en faisant correspondre les éléments et les couleurs ensemble, en privilégiant le raccord des motifs en joint longitudinal.**

The join is made according to the different elements and colors, with a preference for the longitudinal seam pattern.

Die Bahnen sollen so ausgerichtet werden, dass Muster und Farben an den Längsnähten zusammenpassen. Die Verbindungsstelle ist an einer geeigneten Stelle zu wählen, dort wo Muster und Farben zusammenpassen.

Ex : dessin Pompadour, perte maximum de 40 cm. en hauteur ou en largeur

e.g. the Pompadour design should have a maximum overlap of 40 cm in height or width.

z.B. : Design Pompadou, Verschnitt max 40 cm in der Höhe oder Breite.

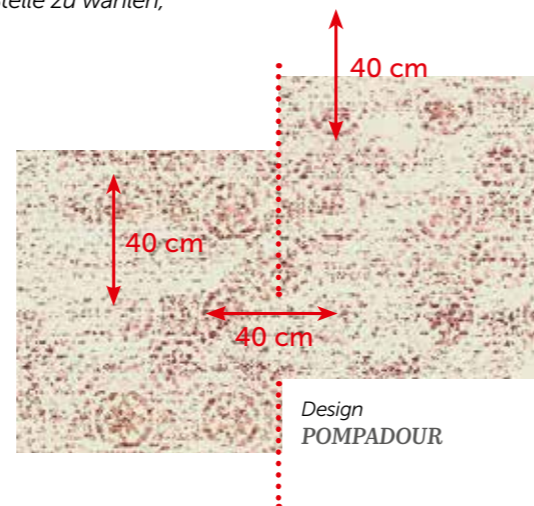

## MEASURE & JOIN

**Le dessin est formel et nécessite un respect impératif du raccord.**

With the formal design, joins must be respected.

Das formale Muster erfordert, dass zwingend auf die Verbindungsstelle geachtet wird.

**Raccorder précisément le motif en longueur et largeur. Reportez-vous au raccord technique de votre dessin.**

Connect the pattern precisely in both length and width. Refer to the technical join for your design.

Das Motiv genau in der Höhe und der Breite ausrichten. Bitte beachten Sie hierzu die technischen Hinweise zum Rapport des Designs.



## RACCORDEMENT EN ANGLE

ANGLED JOINS / VERBINDUNGSSTELLEN IN ECKEN

**Découpe à angle +/-45°**  
Angled cut / Winkelschnitt +/- 45°

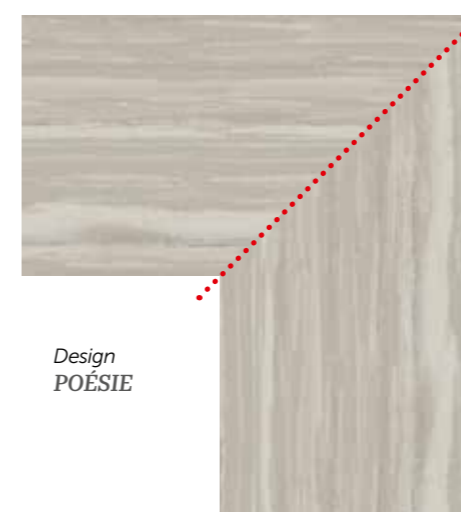

**Découpe droite**  
Straight cut / Gerader Schnitt 90



Pour les autres dessins, nous consulter.  
For other designs, please contact us / Für andere Designs fragen Sie uns bitte an.





# Vision of Elegance

## STANDARD & CUSTOM

$\leq 2\text{KV}$   $<0,15\text{m}^2/\text{W}$   $\Delta\text{Lw } 30\text{dB}$   
 FullColors CORE SYSTEM  
 € € € €

<b>STRUCTURE / CONSTRUCTION / STRUKTUR</b>	Moquette à velours Coupé – Technologie CYP-Colortec+	Tufted carpet, cut pile – CYP-Colortec+ Technology	Getufteter Velours – CYP-Colortec+ Technologie
<b>COMPOSITION / PILE MATERIAL / POLMATERIAL</b>	100% Polyamide teint masse, 4m	100% solution dyed nylon, 4m	100% PA Düsen gefärbt, 4m
<b>POIDS DE VELOURS / POIDS VELOURS UTILE</b> PILE WEIGHT / SURFACE PILE WEIGHT POLEINSATZGEWICHT / NUTZSCHICHTGEWICHT <b>NF ISO 8543</b>	1250 g/m <sup>2</sup>	1250 g/m <sup>2</sup> 36,9 oz/sq yd	1250 g/m <sup>2</sup>
<b>POIDS TOTAL / TOTAL WEIGHT / GESAMTGEWICHT</b> NF ISO 8543	2670 g/m <sup>2</sup>	2670 g/m <sup>2</sup> 78,7 oz/sq yd	2670 g/m <sup>2</sup>
<b>ÉPAISSEUR TOTALE / TOTAL THICKNESS / GESAMTDICKE</b> NF ISO 1765	10 mm	10 mm 0,394"	10 mm
<b>HAUTEUR DU VELOURS / PILE HEIGHT / POLHÖHE</b> NF ISO 1766	6,3 mm	6,3 mm 0,248"	6,3 mm
<b>JAUGE - SERRAGE (POINTS) - DENSITÉ / GAUGE - ROWS(POINTS) - TUFTS / TEILUNG - STICHE (POINTS) - NOPPEN-ZAHL</b> NF ISO 1763	1/10 - 46 p - 184 000 p/m <sup>2</sup>	1/10 - 46 p - 184 000 p/m <sup>2</sup> 1/10 - 11,7 stiches per inch - 151 925 p/in <sup>2</sup>	1/10 - 46 p - 184 000 p/m <sup>2</sup>
<b>ENVERS / BACKING / RÜCKENAUSSTATTUNG</b>	Action Back (AB)	Action Back (AB)	Action Back (AB)
<b>COMPORTEMENT AU FEU / FIRE RESISTANCE / BRENNVERHALTEN</b>	Bfl-s1 - collé sur ciment Cfl-s1 - collé sur bois	Bfl-s1 - glued on cement Cfl-s1 - glued on wood	Bfl-s1 - geklebt auf Zement Cfl-s1 - geklebt auf Holz
<b>CLASSEMENT / WEAR CLASSIFICATION / BEANSPRUCHUNG</b>	Classe 33 LC4 PRODIS N° 977FFBB7	Classe 33 LC4 PRODIS N° 977FFBB7	Classe 33 LC4 PRODIS N° 977FFBB7
<b>LEED® / LEED® / LEED®</b>	Ce produit va contribuer à gagner des points dans le cadre du Leed version 4 et répondre aux exigences relatives à la qualité des environnements intérieurs : Matériaux à faible émission.	This product can help you earn points within the framework of Leed version 4 and meet the requirements regarding indoor environmental quality: Low-emitting materials.	Dieses Produkt trägt dazu bei, Punkte im Rahmen des Leed-Programms Version 4 zu sammeln und die Anforderungen hinsichtlich der Innenraumqualität zu erfüllen: Materialien mit geringen Emissionen.
<b>ISOLATION AUX BRUITS D'IMPACTS / IMPACT SOUND INSULATION / TRITTSCHALLDÄMMUNG</b> <b>NF EN ISO 140-8</b>	$\Delta\text{Lw } 30\text{dB}$	$\Delta\text{Lw } 30\text{dB}$	$\Delta\text{Lw } 30\text{dB}$
<b>ABSORPTION AUX BRUITS AÉRIENS / SOUND ABSORPTION / SCHALLABSORPTIONSGRAD</b> <b>NF EN ISO 11654</b>	$\alpha_w 0,25$ f/Hz 125 250 500 1000 2000 4000 as 0,03 0,08 0,14 0,44 0,42 0,53	$\alpha_w 0,25$ f/Hz 125 250 500 1000 2000 4000 as 0,03 0,08 0,14 0,44 0,42 0,53	$\alpha_w 0,25$ f/Hz 125 250 500 1000 2000 4000 as 0,03 0,08 0,14 0,44 0,42 0,53
<b>POSE/ENTRETIEN/TRAIEMENT / LAYING / CLEANING/TREATMENT / VERLEGEHINWEIS / REINIGUNG / BEHANDLUNG</b>	Bohème, Flore, Poésie, Pompadour, Romance : LOOK & MATCH Dandy, Smart : MEASURE & JOIN www.balsan.com	Bohème, Flore, Poésie, Pompadour, Romance : LOOK & MATCH Dandy, Smart : MEASURE & JOIN www.balsan.com	Bohème, Flore, Poésie, Pompadour, Romance : LOOK & MATCH Dandy, Smart : MEASURE & JOIN www.balsan.com
<b>RACCORDS / REPEATS / VERBINDUNGEN</b>	Selon dessin	According to pattern	Nach Zeichnung



# Vision of Elegance Confort +

## >1000m<sup>2</sup>

$\leq 2\text{KV}$   $\Delta\text{Lw } 36\text{dB}$   $\alpha_w 0,35$   $>7/8$   
 Confort +  
 FullColors CORE SYSTEM  
 € € € €

<b>STRUCTURE / CONSTRUCTION / STRUKTUR</b>	Moquette à velours Coupé – Technologie CYP-Colortec+	Tufted carpet, cut pile – CYP-Colortec+ Technology	Getufteter Velours – CYP-Colortec+ Technologie
<b>COMPOSITION / PILE MATERIAL / POLMATERIAL</b>	100% Polyamide teint masse, 4m	100% solution dyed nylon, 4m	100% PA Düsen gefärbt, 4m
<b>POIDS DE VELOURS / POIDS VELOURS UTILE</b> PILE WEIGHT / SURFACE PILE WEIGHT POLEINSATZGEWICHT / NUTZSCHICHTGEWICHT <b>NF ISO 8543</b>	1250 g/m <sup>2</sup>	1250 g/m <sup>2</sup> 36,9 oz/sq yd	1250 g/m <sup>2</sup>
<b>POIDS TOTAL / TOTAL WEIGHT / GESAMTGEWICHT</b> NF ISO 8543	2905 g/m <sup>2</sup>	2905 g/m <sup>2</sup> 85,7 oz/sq yd	2905 g/m <sup>2</sup>
<b>ÉPAISSEUR TOTALE / TOTAL THICKNESS / GESAMTDICKE</b> NF ISO 1765	12,3 mm	12,3 mm 0,484"	12,3 mm
<b>HAUTEUR DU VELOURS / PILE HEIGHT / POLHÖHE</b> NF ISO 1766	7,2 mm	7,2 mm 0,248"	7,2 mm
<b>JAUGE - SERRAGE (POINTS) - DENSITÉ / GAUGE - ROWS(POINTS) - TUFTS / TEILUNG - STICHE (POINTS) - NOPPEN-ZAHL</b> NF ISO 1763	1/10 - 46 p - 184 000 p/m <sup>2</sup>	1/10 - 46 p - 184 000 p/m <sup>2</sup> 1/10 - 11,7 stiches per inch - 151 925 p/in <sup>2</sup>	1/10 - 46 p - 184 000 p/m <sup>2</sup>
<b>ENVERS / BACKING / RÜCKENAUSSTATTUNG</b>	Confort+ (C+)	Confort+ (C+)	Confort+ (C+)
<b>COMPORTEMENT AU FEU / FIRE RESISTANCE / BRENNVERHALTEN</b>	Cfl-s1 - collé sur ciment	Cfl-s1 - glued on cement	Cfl-s1 - geklebt auf Zement
<b>CLASSEMENT / WEAR CLASSIFICATION / BEANSPRUCHUNG</b>	Classe 33 LC4	Classe 33 LC4	Classe 33 LC4
<b>ISOLATION AUX BRUITS D'IMPACTS / IMPACT SOUND INSULATION / TRITTSCHALLDÄMMUNG</b> <b>NF EN ISO 140-8</b>	$\Delta\text{Lw } 36\text{dB}$	$\Delta\text{Lw } 36\text{dB}$	$\Delta\text{Lw } 36\text{dB}$
<b>ABSORPTION AUX BRUITS AÉRIENS / SOUND ABSORPTION / SCHALLABSORPTIONSGRAD</b> <b>NF EN ISO 11654</b>	$\alpha_w 0,35$ f/Hz 125 250 500 1000 2000 4000 as 0,04 0,08 0,48 0,33 0,43 0,55	$\alpha_w 0,35$ f/Hz 125 250 500 1000 2000 4000 as 0,04 0,08 0,48 0,33 0,43 0,55	$\alpha_w 0,35$ f/Hz 125 250 500 1000 2000 4000 as 0,04 0,08 0,48 0,33 0,43 0,55
<b>POSE/ENTRETIEN/TRAIEMENT / LAYING / CLEANING/TREATMENT / VERLEGEHINWEIS / REINIGUNG / BEHANDLUNG</b>	Bohème, Flore, Poésie, Pompadour, Romance : LOOK & MATCH Dandy, Smart : MEASURE & JOIN www.balsan.com	Bohème, Flore, Poésie, Pompadour, Romance : LOOK & MATCH Dandy, Smart : MEASURE & JOIN www.balsan.com	Bohème, Flore, Poésie, Pompadour, Romance : LOOK & MATCH Dandy, Smart : MEASURE & JOIN www.balsan.com
<b>RACCORDS / REPEATS / VERBINDUNGEN</b>	Selon dessin	According to pattern	Nach Zeichnung

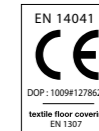

Ce document est fabriqué en impression éco-responsable alliant gestion durable des forêts, encres 100% végétales, énergie solaire et consommation d'eau réduite.

*The environmentally friendly printing process used to produce this document involves sustainable forest management, 100% plant-based inks, solar energy and reduced water consumption.*

*Für die Herstellung dieses Dokuments wurde ein ökologisches Druckverfahren verwendet, wobei nachhaltige Forstwirtschaft, rein pflanzliche Farben, Solarenergie und reduzierter Wasserverbrauch miteinander kombiniert wurden.*

Création et réalisation : Nathalie Dessaux  
 Textes : Bien sincèrement  
 Crédits photographiques : Atelier Arnaud Sabatier,  
 Tanguy de Montesson, Charles Siaux, Nathalie Dessaux,  
 AdobeStock, Shutterstock, Istockphoto, Unsplash, Getty images,  
 The Metropolitan Museum of Art, [www.metmuseum.org](http://www.metmuseum.org),  
 Impression : Picking Graphic • Mars 2022



Les écrans d'ordinateur ou la matière papier affichant les couleurs différemment, nous ne pouvons pas garantir que la couleur du fil sur votre écran ou sur cette brochure reflètent exactement les véritables couleurs des moquettes. N'hésitez pas à contacter l'équipe Balsan pour avoir des échantillons ou consulter le coffret de pompons Color Vision pour une personnalisation.

*Since computer screens and paper display colours differently, we cannot guarantee that the colour of the yarn on your screen or in this brochure accurately reflects the colours of the carpets. You can contact the Balsan team to request samples or to request the Color Vision pompom box if you are interested in customisation.*

*Da Farben am Bildschirm und auf Papier anders wiedergegeben werden, können wir nicht garantieren, dass die am Bildschirm oder in dieser Broschüre angezeigte Garnfarbe der tatsächlichen Farbe der Teppichböden entspricht. Bitte kontaktieren Sie das Balsan-Team, um Farbmuster zu erhalten oder den Color-Vision-Musterkoffer mit Garnproben für individuelle Gestaltungsmöglichkeiten einzusehen.*

## COLOR VISION

	A	B	C	D	E	F	G	G	I	J	K	L
1												
	628	506	546	451	421	411	361	327	381	351	311	321
2												
	512	521	541	551	552	761	746	751	774	771	663	003
3												
	531	556	581	550	460	580	740	765	785	791	726	004
4												
	536	841	594	570	555	440	370	660	760	778	656	626
5												
	851	831	891	585	560	525	340	640	735	766	631	621
6												
	826	861	876	590	575	510	650	610	630	716	611	002
7												
	821	828	881	190	865	925	005	605	730	966	923	006
8												
	133	166	198	150	145	110	910	710	920	946	931	922
9												
	121	156	176	170	140	115	935	950	955	981	968	926
10												
	131	158	196	185	135	255	245	960	990	986	983	961
11												
	118	151	188	285	270	240	215	780	995	974	161	956
12												
	136	167	291	261	246	231	264	281	296	796	273	664
13												
	108	123	132	253	241	221	212	226	276	251	233	211

COLOR  
YOUR  
DREAMS\*

**BALSAN**

2, Corbilly  
B.P. 50  
F-36330 ARTHON  
**+33 (0)2 54 29 16 00**

**balsan.com**



**Designed & Made in France**

\*Colorez vos rêves

